

Architectural
Woodwork Standards

**WALL/CEILING SURFACING
& PARTITIONS**

SECTION

SECTION 8

Wall/Ceiling Surfacing and Partitions

table of contents

INTRODUCTORY INFORMATION

| | |
|---|-----|
| Guide Specifications | 194 |
| Introduction | 195 |
| Wall and Ceiling Surfacing | 195 |
| Opaque | 195 |
| Transparent | 195 |
| Contract Documents | 195 |
| Product Advisory | 195 |
| Panel Sequence | 196 |
| Sequencing of Panels Within a Room | 197 |
| Premanufactured Sequenced Sets | 198 |
| Full Width Panel Utilization | 198 |
| Selectively Reduced Panel Utilization | 200 |
| Made to Order Sequenced Matched Panels | 201 |
| Made to Order Blueprint Matched Panels and Components | 202 |
| Flitch Selection | 203 |
| Variations in Natural Wood Products | 203 |
| High Pressure Decorative Laminates (HPDL) | 203 |
| Standing and Running Trim | 203 |
| Smoothness of Flat and Molded Surfaces | 204 |
| Installation | 204 |
| Finishing | 204 |
| Fire Retardance and Treatment | 204 |
| Fire Retardant Panel Products | 204 |
| Examples | 205 |
| Edgebanding | 205 |
| Field Cut Corner and Transition | 205 |
| Reveals and Reveal Joint | 205 |
| Factory Prepared Corner and Transition | 206 |
| Factory Prepared Transition | 206 |
| Wall Panels with Millwork | 207 |
| Stile and Rail Paneling | 208 |
| Flat Paneling with Reveals within a Niche | 209 |
| Paneling for Reception Wall with Factory Built Structures | 210 |
| Specify Requirements For | 211 |
| Recommendations | 211 |

COMPLIANCE REQUIREMENTS

GENERAL

| | |
|-------------------------------------|-----|
| Basic Considerations | 212 |
| Grades | 212 |
| Economy | 212 |
| Custom | 212 |
| Premium | 212 |
| Grade Limitations | 212 |
| Contract Documents | 212 |
| Acceptable Requirements | 212 |
| Aesthetic Compliance | 212 |
| Exposed Surfaces | 213 |
| Concealed Surfaces | 212 |
| Solid Surface | 212 |
| Solid Phenolic | 212 |
| HPDL Backed Wood Veneers | 212 |
| Continuous Pressure Laminates | 212 |
| Furring | 212 |
| Bleached Veneers | 212 |
| High Gloss HPDL | 212 |
| To Prevent Telegraphing | 212 |
| Industry Practices | 212 |
| Structural Members | 212 |
| Wall, Ceiling and Floor | 212 |
| Priming | 213 |
| Radius Molding | 213 |
| Wainscot | 213 |
| Wall Surfacing | 213 |

PRODUCT

| | |
|---------------------------|-----|
| Scope | 214 |
| Typical Inclusions | 214 |
| Typical Exclusions | 214 |
| Default Stipulation | 214 |
| Wood | 214 |
| HPDL | 214 |
| Solid Surface | 214 |
| Solid Phenolic | 214 |

table of contents

COMPLIANCE REQUIREMENTS (continued)

PRODUCT (continued)

| | |
|---|-----|
| Rules | 215 |
| Errata | 215 |
| Basic Rules | 215 |
| Aesthetic | 215 |
| Lumber | 215 |
| Sheet Products | 215 |
| Backing Sheet | 215 |
| Exposed Surfaces | 215 |
| Concealed Surfaces | 215 |
| Wainscot | 215 |
| Furring | 215 |
| Defined Grain | 215 |
| Multiple Options | 215 |
| Flame Spread Rating | 215 |
| Specific Profile | 215 |
| If no species is specified for transparent finish | 215 |
| Where Gluing or Lamination | 215 |
| Cut outs | 215 |
| Cathedral | 215 |
| Single Source | 215 |
| First Class Workmanship | 215 |
| Material Rules | 216 |
| Species | 216 |
| Lumber, Veneered Profile or Sheet Products | 216 |
| Defects | 216 |
| Figure | 216 |
| Warp | 216 |
| Partition Cores | 216 |
| Opaque Finish | 216 |
| Transparent Finish Veneer | 216 |
| Exposed Surfaces | 216 |
| Transparent Finish | 216 |
| Concealed Surfaces | 216 |
| Wood Veneer | 216 |
| Cores | 217 |

| | |
|--------------------------------------|-----|
| Matching | 217 |
| Opaque | 217 |
| Transparent | 217 |
| Edge Reveals | 217 |
| Bleed Through | 217 |
| Flame Spread Rated | 217 |
| Solid Stile and Rail | 217 |
| Lumber | 217 |
| Veneer | 217 |
| Opaque | 217 |
| Transparent | 217 |
| Panels | 217 |
| Solid Wood Surfacing | 218 |
| Decorative Laminate | 218 |
| Conformance to NEMA LD-3 | 218 |
| Adjacent Sheets | 218 |
| Flame Spread | 218 |
| Patterned or Wood Grain | 218 |
| Cores | 218 |
| Backing Sheet | 218 |
| Visible Splines and Reveals | 218 |
| Edgebanding | 219 |
| Solid Surface | 219 |
| Solid Phenolic | 219 |
| Priming | 219 |
| Machining Rules | 219 |
| Exposed Surfaces | 219 |
| Sharp Edges | 219 |
| Top Flat Surfaces | 219 |
| Profiled and Shaped Wood | 219 |
| HPDL, PVC and Prefinished Wood | 219 |
| Overlap, Test F | 219 |
| Chip out, Test G | 219 |
| Over Machined, Test H | 220 |
| Turned Wood | 220 |
| Cross Sanding | 220 |
| Tear out, Knife Nicks | 220 |
| Knife Marks | 220 |

SECTION 8

Wall/Ceiling Surfacing and Partitions

table of contents

COMPLIANCE REQUIREMENTS (continued)

PRODUCT (continued)

Rules (continued)

Machining Rules (continued)

Exposed Surfaces (continued)

Glue or Filler 220

Solid Surface. Solid Phenolic, Epoxy Resin 220

Assembly Rules 220

These Standards 220

Joints at Assembled Woodwork 220

Securely Glued 220

Reinforced 220

Mechanically Fastened 220

Visible Fasteners 220

Flushness Variations 220

Gap Test A 221

Gap Test B 221

Gap Test C 221

Miter Joints 221

Built Up Items 221

Flatness or Warp, Test E 221

Wood Veneer 222

Panels 222

Veneer Sequence 222

Butt Joints 222

Reveal Joints and Corners 222

Inside Corners 222

Mitered 222

Field Joinery 222

Exposed Corners 222

Moldings 222

Veneer Joints 222

Veneer Loss, Side 223

Veneer Loss, End 223

End Matched Veneer Misalignment 223

Figure 223

Solid Stile and Rail Wood 223

Paneling 223

Field Joints 223

Decorative Laminate 223

Alignment Variations 223

Plumbness 223

Gap Test M 223

Flushness Test N 223

Retention Moldings 223

Vertical Horizontal Joints 223

Panels 224

Butt Joints 224

Reveal Joints and Corners 224

Inside Corners 224

Mitered Outside Corners 224

Solid Surface 224

Butt Joint 224

Vertical Joints 224

Expansion 224

Solid Phenolic 224

Joint Width 224

Joints 224

Trims or Gaskets 224

INSTALLATION

Care, Storage and Building Conditions 225

Contractor is Responsible for 225

Installer is Responsible for 225

Rules 226

Errata 226

Basic Rules 226

Aesthetics 226

Transparent Finished 226

Repairs 226

Installer Modifications 226

Woodwork 226

These Standards 226

table of contents

| | |
|--|-----|
| Gaps Test I..... | 227 |
| Flushness Test J..... | 227 |
| Reveals at Adjoining Panel Gaps Test K..... | 227 |
| Flushness at Adjoining Panel Flushness Test L..... | 228 |
| Fastening | 228 |
| Reveal Strips..... | 228 |
| Expansion Joints..... | 228 |
| Paneling | 228 |
| Joints..... | 228 |
| Backs | 228 |
| Flatness of Panels Test E..... | 228 |
| Glue..... | 229 |
| Equipment Cutouts..... | 229 |
| Hardware..... | 229 |
| Areas of Installation..... | 229 |
| First Class Workmanship | 229 |
| Specific Rules..... | 229 |
| Veneered Panels..... | 229 |
| Solid Wood Surfacing..... | 230 |
| Decorative Laminate | 230 |
| Solid Surface..... | 230 |
| Solid Phenolic | 230 |
| TESTS | |
| Basic Considerations..... | 231 |
| Fabricated and Installed | 231 |
| Smoothness..... | 231 |
| KCPI..... | 231 |
| Sanding | 231 |
| Gaps, Flushness, Flatness and Alignment | 231 |
| Illustrations | 232 |

Guide Specifications

Are available through the Sponsor Associations in interactive digital format including unique and individual quality control options.

The Guide Specifications are located at:

Architectural Woodwork Institute (AWI)

www.awinet.org

8

Architectural Woodwork Manufacturers Association of Canada (AWMAC)

<http://awmac.com/aws-guide-specifications>

Woodwork Institute (WI)

www.woodworkinstitute.com/publications/aws_guide_specs.asp

introductory information

INTRODUCTION:

Section 8 includes information on wood veneer, solid wood, stile and rail wood, decorative laminate, solid surface and solid phenolic products and their related parts.

Quality assurance can be achieved by adherence to the AWS and will provide the owner a quality product at competitive pricing. Use of a qualified Sponsor Member firm to provide your woodwork will help ensure the manufacturer's understanding of the quality level required. Illustrations in this Section are not intended to be all inclusive. Other engineered solutions are acceptable. In the absence of specifications, methods fabrication shall be at the option of the manufacturer. The design professional, by specifying compliance to the AWS increases the probability of receiving the product quality expected.

WALL and CEILING SURFACING:

Includes wood veneered panels, solid wood, decorative plastic laminate, solid surface, solid phenolic panels and factory built framing for surfacing.

Contract documents, furnished by the design professional, shall clearly indicate or delineate material, fabrication, installation, and applicable building code/regulation requirements.

Shop drawings, engineering, listings and mockups are the means by which the design intent is turned into reality. They shall indicate methods of construction, exact material selections, grain direction(s), methods of attachment and joinery, and exact dimensions. They should also include the manufacturer's technical suggestions. Listings (schedules) are sometimes used to list core, edge and face materials, adhesives etc. when not included on the shop drawings. Mockups may be specified for review as a full scale model showing, materials, joinery and finishes and are often used as the project control sample.

MATERIAL SELECTIONS:

For **OPAQUE** finishes:

- Medium Density Fiberboard (MDF) is suggested for cost savings and an optimum paintable surface.
- Medium Density Overlay (MDO) which may be machined and detailed with little loss of quality surface characteristics, requires a seal coat prior to application of finish coats with no sheen limitation.
- Medium Density Overlay (MDO) - This provides a paintable surface for panels. The thermosetting resin overlay is designed to take and hold paint. Opaque finish sheens above 40 Satin require special finishing procedures.
- Close Grain Hardwood - Although allowed, extra preparation may be required by the finisher as there may be grain show-through, split veneer joints, and other wood characteristics.
- Manufacturers' option - Face materials are determined by the manufacturer.

For **TRANSPARENT** finishes:

Selection starts by looking at "hand samples," pieces of veneer or lumber representing a particular species, but not necessarily a particular tree or log. Wood is a natural material (unlike a manufactured product), which varies from tree to tree in its color and texture. Rather than simply choosing an appropriate wood for its color, consider the size and availability of the species. A species that grows in smaller diameter, with shorter logs, lends itself to furniture and smaller projects, whereas an abundant species that grows in large diameter lends itself more to larger public spaces. Many projects have run into difficulties because the species availability was not compatible with the project's needs.

CONTRACT DOCUMENTS SHALL INCLUDE:

- Species, Slicing and Matching of individual leaves are reviewed and governed by Section 4, Sheet Products (Note unless otherwise specified; plain sliced and bookmatch are the default standards).
- Species: There are numerous foreign and domestic species available. Involve your manufacturer early in the design and selection process.
 - Slicing: Select either rotary, plain sliced, quarter sliced, or (in the case of Oak only) rift sliced.
 - Matching of individual leaves: Select either book matched (most appropriate for plain sliced), slip matched (most appropriate for quartered and rift sliced), or random matched (for a rustic look, usually more expensive).
 - Matching on each panel face: Select either running match, balance match, or balance and center match. Specify type of end matching for tall elevations.
 - Sequence matching between full width pre manufactured panel sets.

PRODUCT ADVISORY:

Due to adverse reaction of some veneers laminated to fire rated (FR), ultra low emitting formaldehyde (ULEF or NAUF), medium density fiberboard MDF - causing discoloration of the wood veneer even months after installation, major core manufacturers have issued disclaimers in the use of FR cores. They strongly suggest that use of FR ULEF MDF and particleboard cores should be done after testing compatibility of adhesives, wood veneer and cores. Any resulting discoloration with the use of these cores may be exempt in their warranties. Use of FR ULEF cores should only be considered after consultation with the board supplier.

SECTION 8

Wall/Ceiling Surfacing and Partitions

introductory information

PANEL SEQUENCING:

- **Running Match** (cannot be end matched) - Each panel face is assembled from as many veneer leaves as necessary. This often results in a non-symmetrical appearance, with some veneer leaves of unequal width. Often the most economical method at the expense of aesthetics.

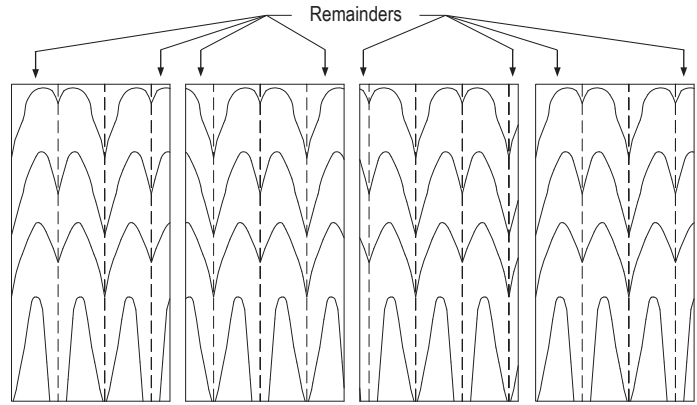

FIGURE: 8-001

- **Balance Match** - Each panel face is assembled from veneer leaves of uniform width before edge trimming. Panels may contain an even (balance and center) or odd (balanced) number of leaves and may change from panel to panel within a sequenced set.

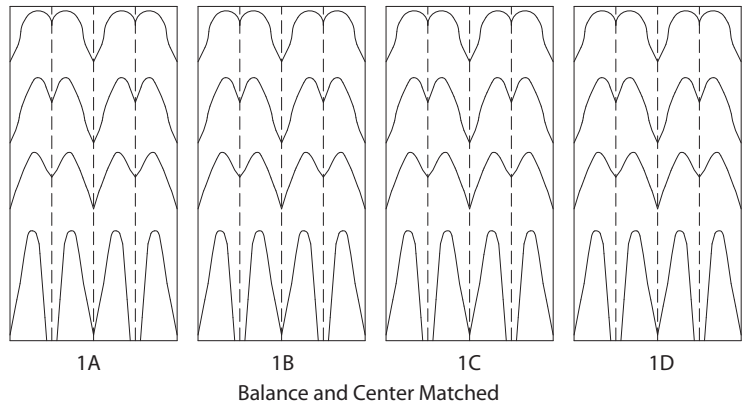

FIGURE: 8-002

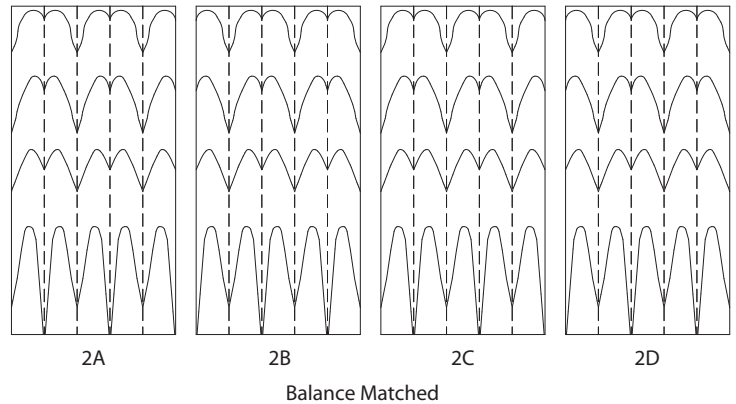

FIGURE: 8-003

introductory information

- Balanced End Match

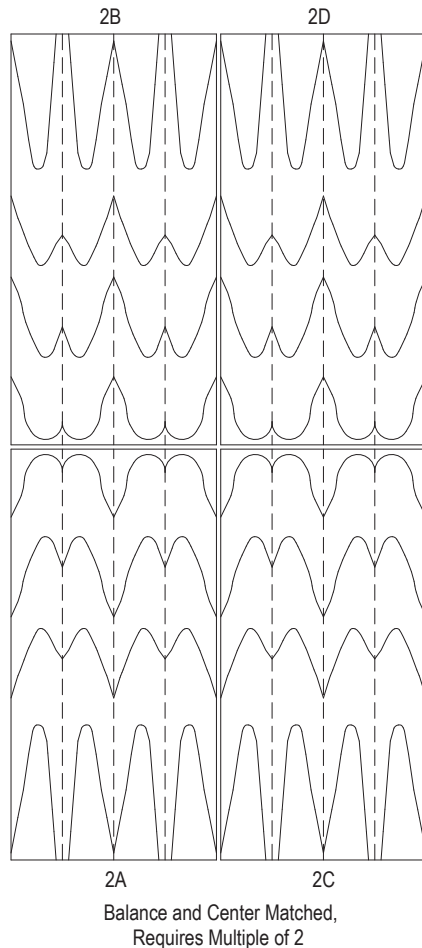

FIGURE: 8-004

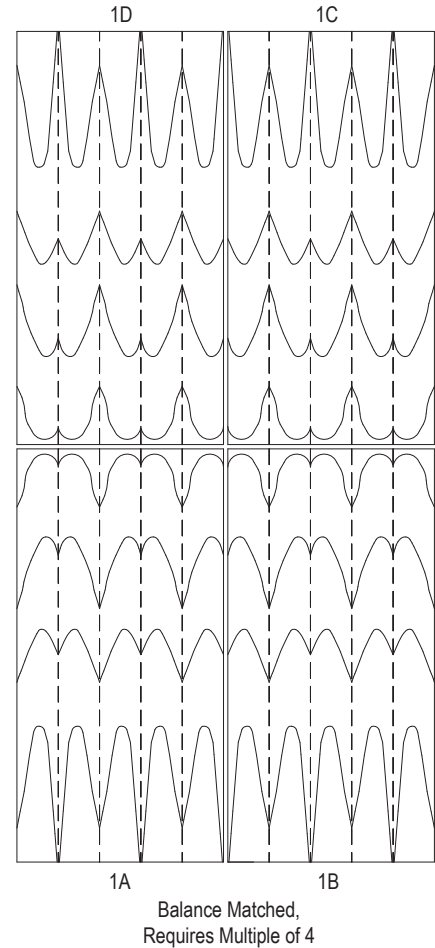

FIGURE: 8-005

SEQUENCING of PANELS WITHIN A ROOM:

Selections include: no sequence, pre-manufactured sets - full width, pre-manufactured sets - selectively reduced in width (equally sized), sequenced uniform size set(s), or blueprint sequenced panels and components.

Although many panel distributors maintain a panel inventory of pre-manufactured sets of different species and grades, only a limited quantity of species, cut and grades will be available.

Sequenced custom sized and blueprint sequenced panels offer variables of veneer leaf match and panel width there for panel sequencing shall not be tried with pre-manufactured panel sets.

Sequenced panels and examples of their room layout are as follows:

SECTION 8

Wall/Ceiling Surfacing and Partitions

introductory information

SEQUENCING of PANELS WITHIN A ROOM (continued):

- **PREMANUFACTURED SEQUENCED SETS**

Full width utilization is composed of a specific quantity of sequenced and numbered panels based on a per room basis for net footage selected from available inventory. They are usually only available in 48" x 96" or 120" (1219 mm x 2438 mm or 3048 mm) sheets in sets varying from 6-12 panels. If more than one set is required, sequencing between sets cannot be expected. Similarly, doors or components cannot be fabricated from the same set.

- **FULL WIDTH PANEL UTILIZATION** with running matched panels.

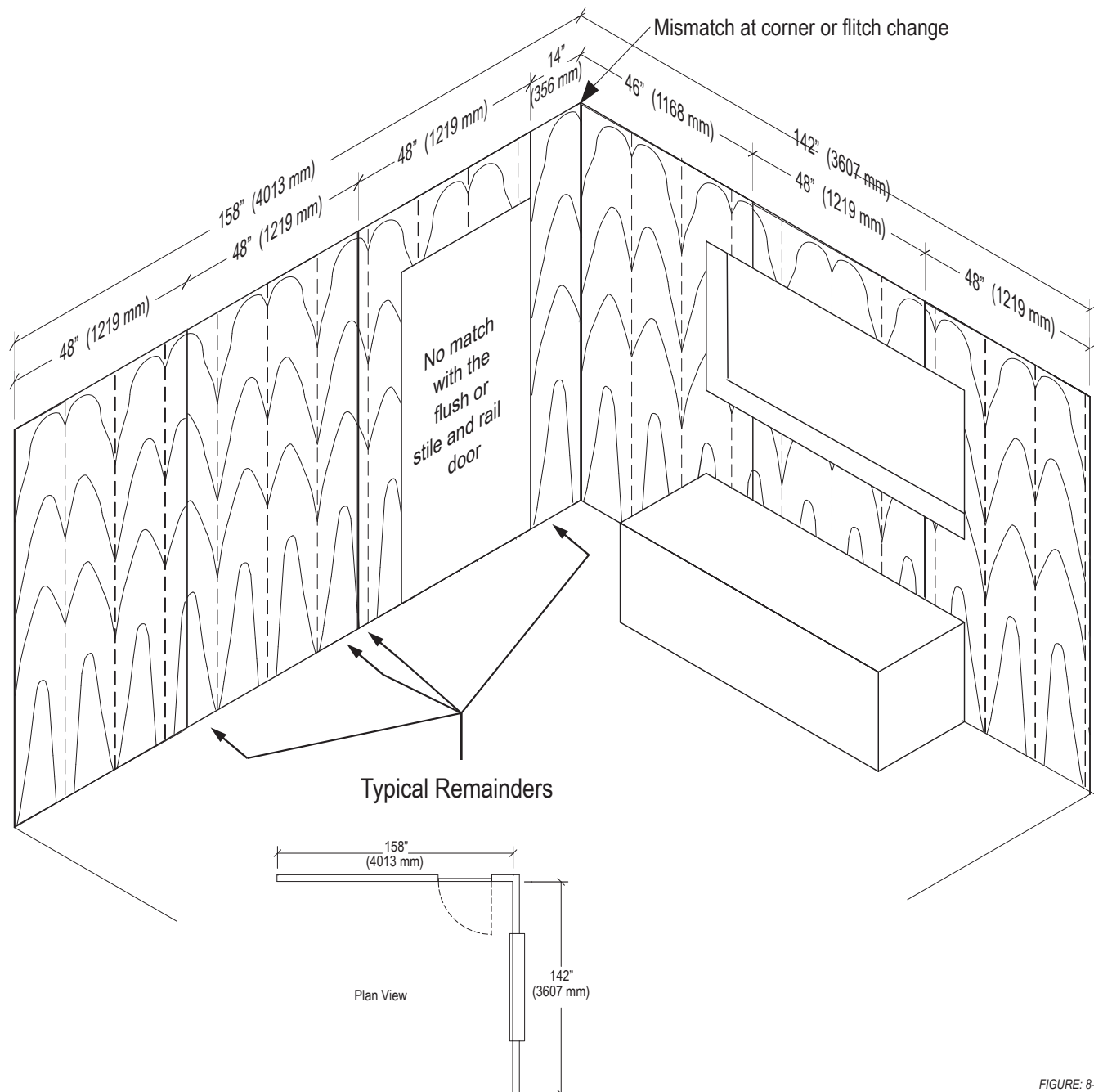

FIGURE 8-006

introductory information

SEQUENCING of PANELS WITHIN A ROOM (continued)

• PRE-MANUFACTURED SEQUENCED SETS (continued)

- FULL WIDTH PANEL UTILIZATION with balanced matched panels.

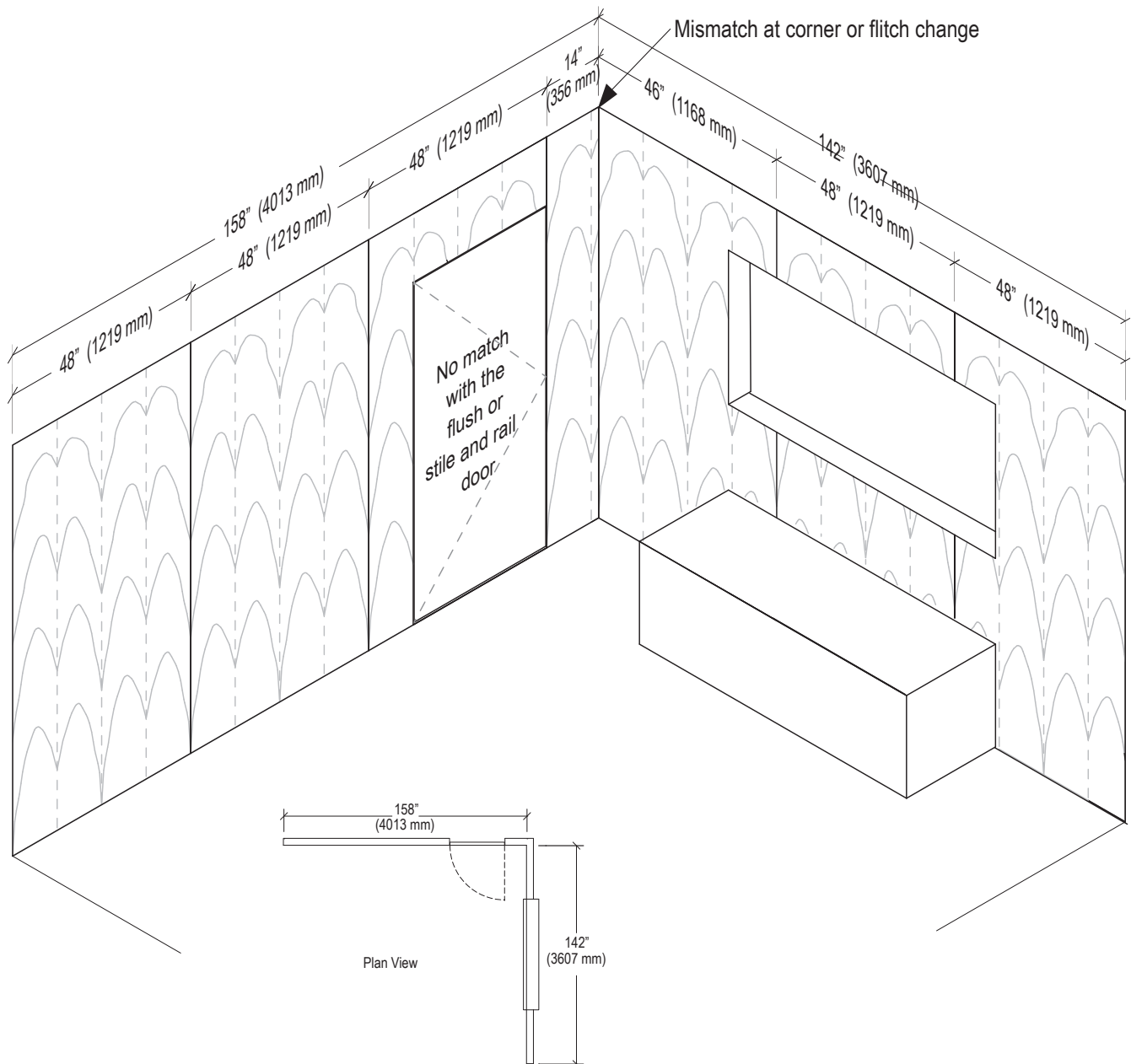

FIGURE 8-006

SECTION 8

Wall/Ceiling Surfacing and Partitions

introductory information

SEQUENCING of PANELS WITHIN A ROOM (continued)

- PRE-MANUFACTURED SEQUENCED SETS (continued)
 - SELECTIVELY REDUCED PANEL UTILIZATION with balanced matched panels.

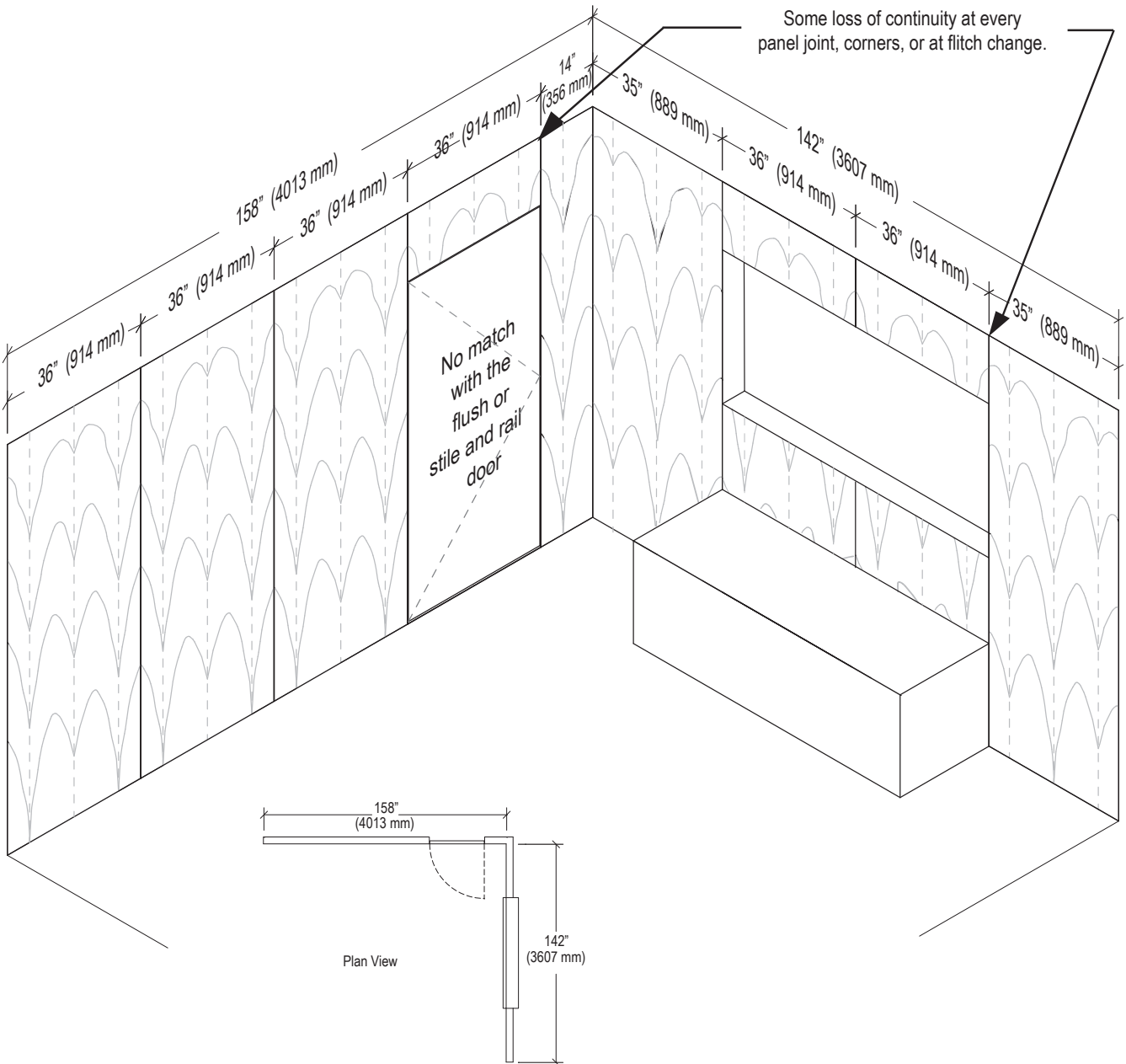

FIGURE 8-007

introductory information

SEQUENCING of PANELS WITHIN A ROOM (continued)

- **MADE TO ORDER SEQUENCED SETS** (must be specified). Balance or balance and center matched panels are manufactured to exact sizes based on the project's net footage and height requirements.

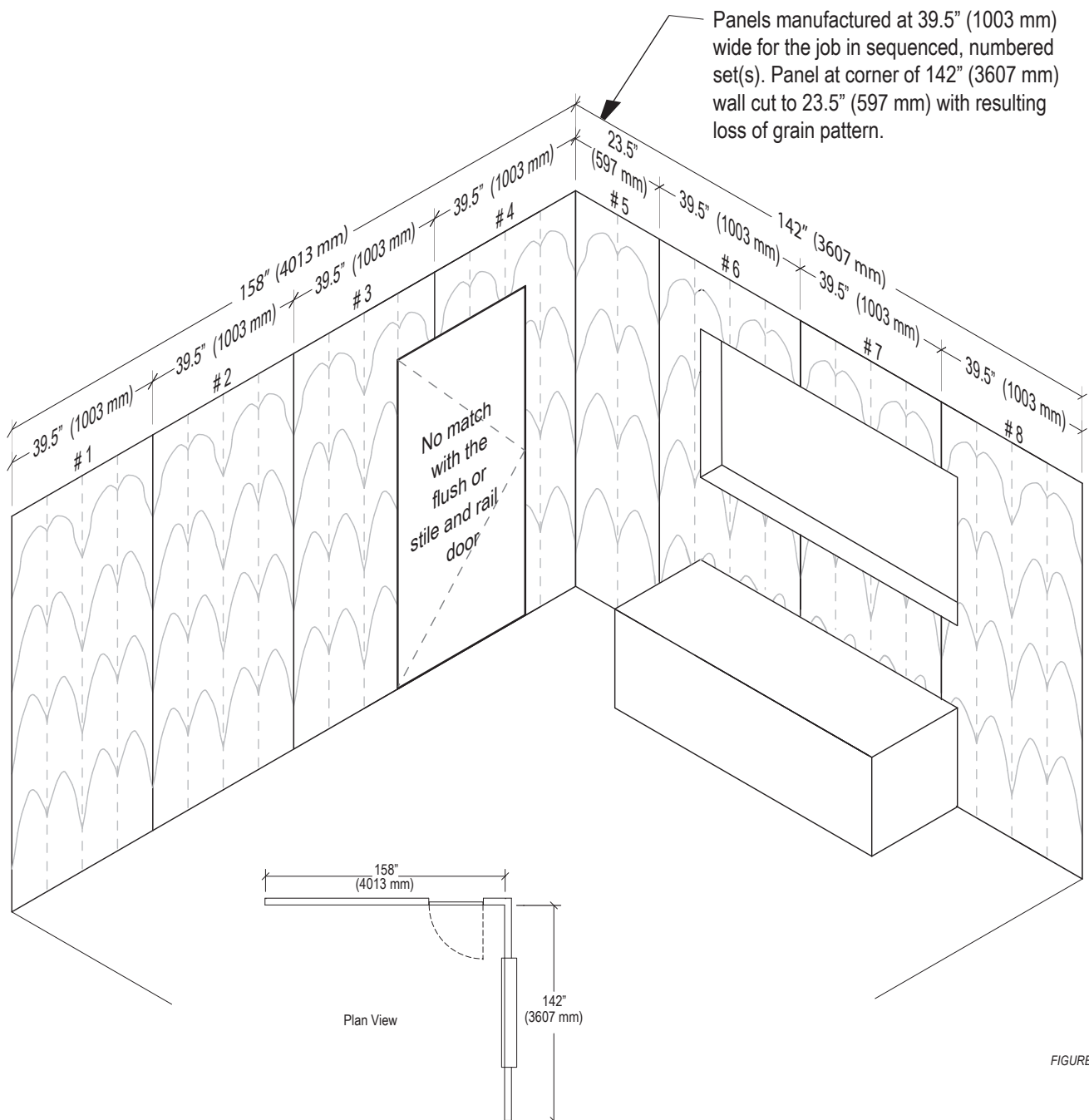

FIGURE: 8-008

SECTION 8

Wall/Ceiling Surfacing and Partitions

introductory information

SEQUENCING of PANELS WITHIN A ROOM (continued)

- **MADE TO ORDER SEQUENCED BLUEPRINT SETS** and **COMPONENTS** (must be specified). Balance and balance and center matched panels are manufactured to the exact sizes the manufacturer determines from the contract drawings, clipping and matching each individual face to the project's specific needs. Each face will be in sequence with adjacent panels, doors, transoms, and cabinet faces as needed for continuity.

Components such as doors, windows, openings and cabinets plus overall room dimensions are the variables that determine panel width. Either balance and/or balance and center matched panels may be used in conjunction with one another to achieve a blueprint sequence. Therefore, grain continuity is maximized, which enhances the overall aesthetics.

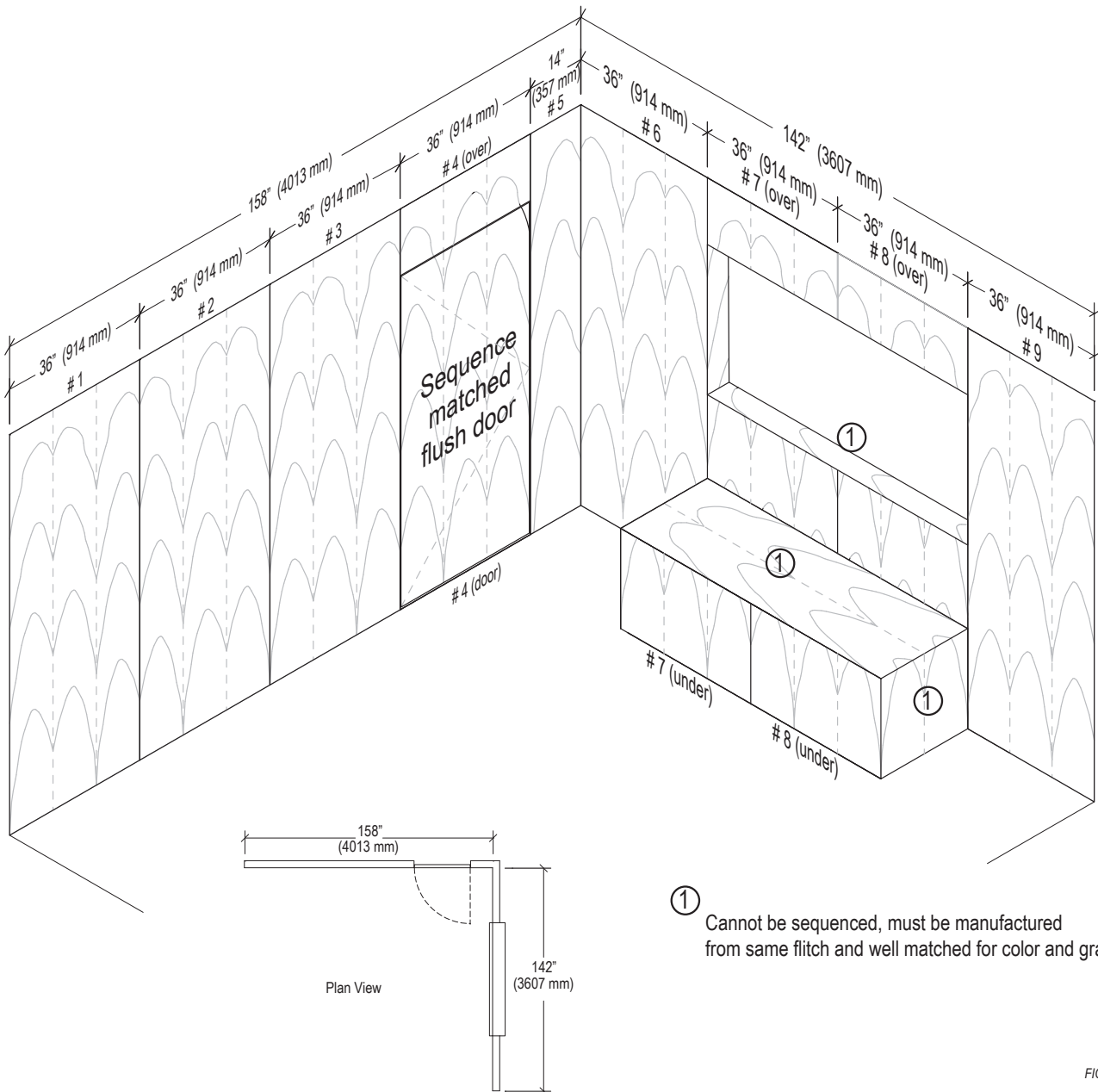

FIGURE: 8-009

introductory information

FLITCH SELECTION

The design professional may choose to see samples of veneer flitches to evaluate color and grain characteristics for other than pre-manufactured sets. This must be specified. Unless specified, layup is determined by the manufacturer.

When it is determined that the use of pre-manufactured panel sets is not adequate for the scope of the project, then selecting specific veneer flitches is an option to consider.

When sliced from a log, the individual pieces of veneer are referred to as leaves. These leaves are kept in order as they are sliced and then dried. As the leaves come out of the dryer, the log is literally reassembled. This sliced, dried and reassembled log or partial log is called a flitch. The flitch is given a number and the gross square footage of the flitch is tallied.

To select specific veneer flitches for a project:

- Determine the net square footage of face veneer required for the project. This should include paneling, casework, built-in furniture, and flush doors items when specifying a blueprint sequenced project.
- Multiply the net square footage times three (this is the average ratio. Some species require a higher multiplier). Example: 5,000 (net square feet) x 3 = 15,000 square feet; this is the gross square footage that should be sampled for this project.

While this may sound like a daunting quantity of veneer to look through, there is an established process that simplifies the task. When a numbered flitch is sampled, typically, three leaves of veneer are removed from the flitch and numbered sequentially. Starting from the top of the flitch, a leaf is removed from one-quarter of the way down, then from one-half, and from three quarters in the flitch. These three sequentially numbered leaves of veneer form a representative sample of that flitch.

- Since it will take at least 6 flitches, with a gross square footage of 2,500 square feet each to meet the project needs, give careful consideration to the following key criteria:
 - **Length** - Is the length adequate for the requirements? The flitch needs to be at least 6" (152 mm) longer than the panel requirements.
 - **Width** - What will the net yield for width be from each flitch?
 - **Gross square footage of each flitch** - total yield must be 15,000 square feet.
 - **Color and grain compatibility** - While exact matching is not possible, from flitch to flitch, this is the opportunity to select the range of color and grain compatibility that will enhance the visual continuity of the entire project.

The reality of this process is that the square footage of individual flitches of veneer will probably range from 1,200 square feet up to 3,000 square feet. This means that one may end up selecting 9 or 10 flitches, instead of just 6. But the goal remains the same as in the example: selecting flitches that will satisfy the aesthetic needs, while fulfilling the face veneer requirements for the project.

It is recommended that specifications be written with the foregoing objective in mind. Then, when the project has been awarded to a qualified manufacturer, talk directly to the manufacturer and be involved in one of the most exciting aspects of bringing the design concepts to reality.

VARIATIONS in NATURAL WOOD PRODUCTS

Wood is a natural material, with variations in color, texture, and figure. These variations are influenced by the natural growing process and are uncontrollable by the manufacturer. The color of wood within a tree varies between the "sapwood" (the outer layers of the tree which continue to transport sap), which is usually lighter in color than the "heartwood" (the inner layers in which the cells have become filled with natural deposits). Various species produce different grain patterns (figures), which influence the selection process. There will be variations of grain patterns within selected species. The architectural woodwork manufacturer cannot select solid lumber cuttings within a species by grain and color in the same manner in which veneers may be selected. Color, texture, and grain variations will occur in architectural woodworking.

HIGH PRESSURE DECORATIVE LAMINATES (HPDL)

- High pressure decorative laminate color and texture can be used in the manufacture of architectural panels and doors with the following cautions:
 - High gloss HPDL will highlight minor core and surface imperfections, often unacceptably.
 - HPDL panels and doors are not recommended for exterior use due to the potential differentials in humidity between the faces.
 - Some HPDLs utilize a WHITE BACKGROUND paper to achieve the high fidelity, contrast, and depth of color of their printed pattern, while leaving a white line at exposed edges, which is extremely noticeable with darker colors.

STANDING AND RUNNING TRIM

Site-applied cornice, chair rail, base, trim, and mouldings are governed by the areas of the Architectural Woodwork Standards covering Standing and Running Trim.

SECTION 8

Wall/Ceiling Surfacing and Partitions

introductory information

SMOOTHNESS of FLAT and MOLDED SURFACES

- **Planers and Molders:** The smoothness of surfaces that have been machine planed or moulded is determined by the closeness of the knife cuts. The closer the cuts to each other (i.e., the more knife cuts per inch [KCPI]), the closer the ridges, and therefore the smoother the resulting appearance.
- **Sanding and Abrasives:** Surfaces can be further smoothed by sanding. Sandpapers come in grits from coarse to fine and are assigned ascending grit numbers. The coarser the grit, the faster the stock removal. The surface will show the striations caused by the grit. Sanding with finer grit papers will produce smoother surfaces.

INSTALLATION

The methods and skill involved in the installation of paneling and doors in large measure determine the final appearance of the project. The design, detailing, and fabrication should be directed toward achieving installation with a minimum of exposed face fastening. The use of interlocking wood cleats or metal hanging clips combined with accurate furring and shimming will accomplish this. Such hanging of panels has the additional advantage of permitting panel movement that results from humidity changes or building movement. Depending upon local practice, many manufacturers will perform the wall preparation and installation of the paneling and related doors.

FINISHING

Site conditions and air quality regulations for finishing are rarely conducive to good results. Poor lighting, dust-laden air, and techniques available are limiting factors. Depending upon local practice, many manufacturers will factory finish, yielding better results than can be achieved from field finishing. Unless specified in the Contract Documents, the manufacturer is not responsible for the appearance of field finished panels or doors.

FIRE RETARDANCE and TREATMENT

The natural fire-retardant qualities and acceptability of treatments vary among the species. Where certain items of architectural woodwork are required to have a flame spread classification to meet applicable building and safety codes, the choice of lumber species must be a consideration. Additional data on various species may be available from U.S. Department of Agriculture Forest Service, Fire Safety of Wood Products Work Unit at (608) 231-9265.

- **Flame Spread Classification:** This is the generally accepted measurement for flame spread rating of materials. It compares the rate of flame spread on a particular species with the rate of flame spread on untreated Oak. Most authorities accept the following classes for flame spread:

- Class I or A 0-25
- Class II or B 26-75
- Class III or C 76-200

- **Fire Retardant Treatments:** Some species may be treated with chemicals to reduce flammability and retard the spread of flame over the surface. This usually involves impregnating the wood, under pressure, with salts suspended in a liquid. The treated wood must be re-dried prior to fabrication. Consult with a manufacturer about the appearance and availability of treated woods prior to specification.

The sizes and species currently being treated (flame spread less than 25), are very limited, and not available in all markets. Fire-retardant treatment does affect the color and finishing characteristics of the wood.

Subject to the authority having jurisdiction, untreated wood and wood products may be used. The location and quantity to be determined by the design professional.

- **Intumescent Coatings for Wood:** It is possible to reduce flammability by using intumescent coatings in either opaque or transparent finishes. These are formulated to expand or foam when exposed to high heat, and create an insulating effect that reduces the speed of spread of flame. Improvements are continually being made on these coatings. Consequently, the specifier must ascertain whether they will be permitted under the code governing the project, the relative durability of the finish, and the effect of the coating on the desired color of the finished product.
- **Finishing Of Fire Retardant Treated Lumber:** Fire-retardant treatments may affect the finishes intended to be used on the wood, particularly if transparent finishes are planned. The compatibility of finishes should be tested before they are applied.

FIRE RETARDANT PANEL PRODUCTS

- **Core** - The flame spread rating of the core material determines the rating of the assembled panel. Fire-retardant veneered panels must have a fire-retardant core. Particleboard core is available with a Class I (Class A) rating. Veneer core and MDF (Medium Density Fiberboard) cores are available with a flame spread rating in some markets.
- **Face** - The International Codes, except where locally amended, provide that facing materials less than 0.036" (0.9mm) or thinner and applied directly to the surface of the walls or ceilings are not required to be tested.

If a Class I (Class A) panel assembly is specified with a decorative laminate face, the decorative laminate and the laminate balancing sheet must be applied to a Class I (Class A) core material, with the laminate manufacturer's recommended adhesive. It is the responsibility of the specifier to indicate what flame spread rating, if any, is required for the paneling. In the absence of such a specified rating, the manufacturer shall supply un-rated paneling.

introductory information

EDGE-BANDING EXAMPLES

Veneer edgebanded:



Figure: 8-010

Inset Solid Wood edgebanding:



Figure: 8-011

Applied Solid Wood with corner joint options:

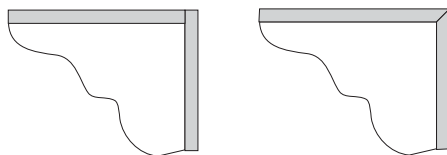
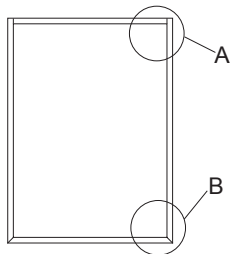

A - Lapped

B - Mitered

Figure: 8-012

For durability, the bottom edge of wall surfacing is edgebanded.

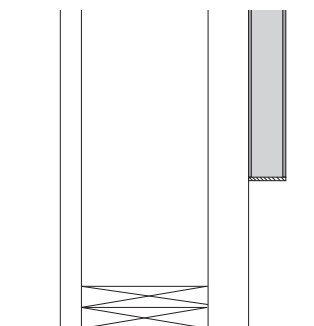

Figure: 8-013

FIELD-CUT CORNER and TRANSITION EXAMPLES

Butt - Outside Corner

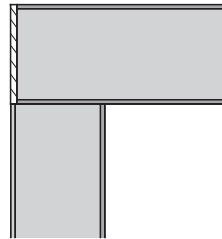

Figure: 8-014

Mitered - Outside Corner

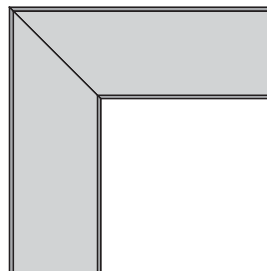

Figure: 8-015

Solid Wood - Outside Corner

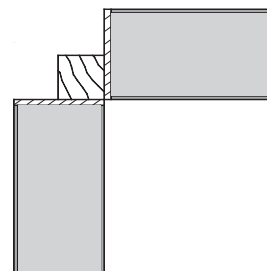

Figure: 8-016

Butt - Inside Corner

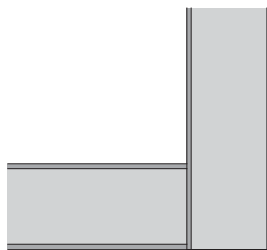

Figure: 8-017

Non-reveal - Transition

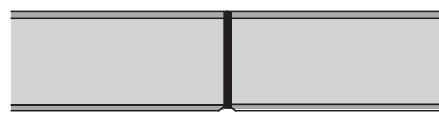

Figure: 8-018

REVEALS and REVEAL JOINT EXAMPLES

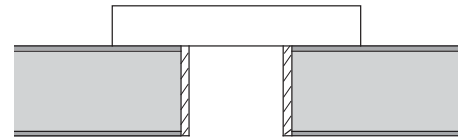

Figure: 8-019

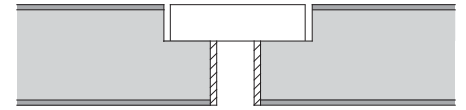

Figure: 8-020

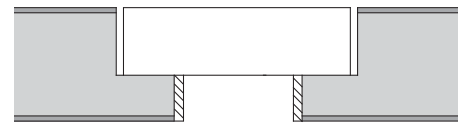

Figure: 8-021

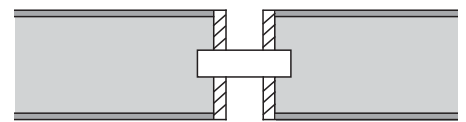

Figure: 8-022

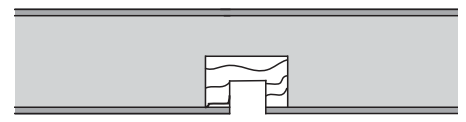

Figure: 8-023

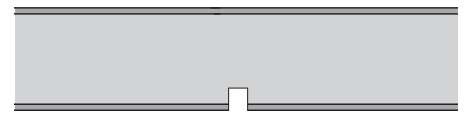

Figure: 8-024



Figure: 8-025

To **PREVENT TELEGRAPHING**, inset solid wood edging when used must have similar moisture content as panel core, be glued securely and calibrated with panel core thickness prior to being laminated with a wood veneer on both faces.

SECTION 8

Wall/Ceiling Surfacing and Partitions

introductory information

REVEALS and REVEAL JOINT (continued)

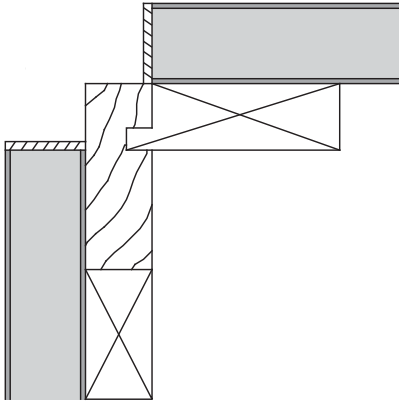

Figure: 8-026

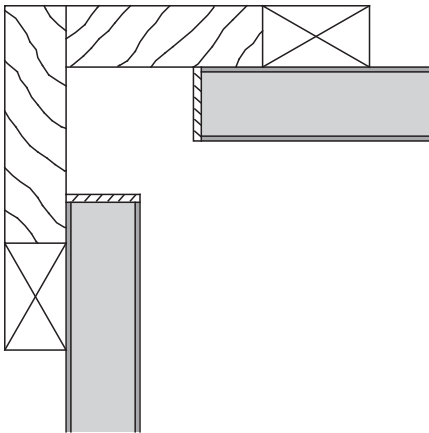

Figure: 8-027

FACTORY-PREPARED CORNER and TRANSITION EXAMPLES

Lock Mitered - Outside Corner

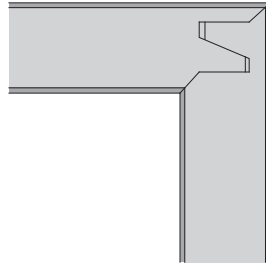

Figure: 8-028

Splined - Outside Corner

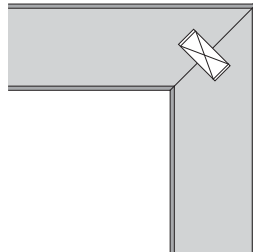

Figure: 8-029

Miter Fold - Outside Corner

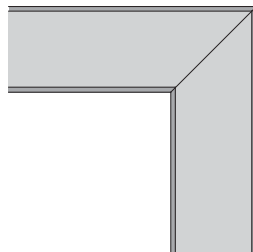

Figure: 8-030

Solid Wood - Outside Corner

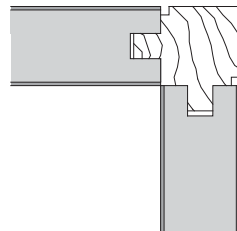

Figure: 8-031

Solid Wood - Outside Corner

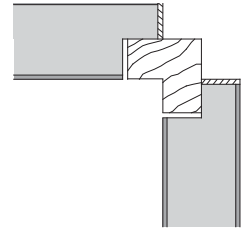

Figure: 8-032

Non-reveal Transition

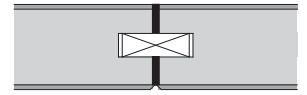

Figure: 8-033

FACTORY PREPARED TRANSITION EXAMPLE of built-up section:

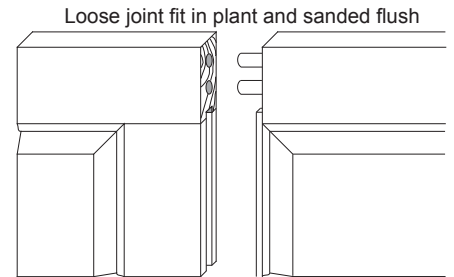

Figure: 8-034

introductory information

STILE and RAIL PANELING

Flat or raised panels with wood veneer faces or of solid lumber, combined with stiles and rails. Design may encompass face application of mouldings. Joints between panels, stiles, rails, and other members to be as designed for functional or decorative purposes.

EXAMPLES of WALL PANELS WITH MILLWORK

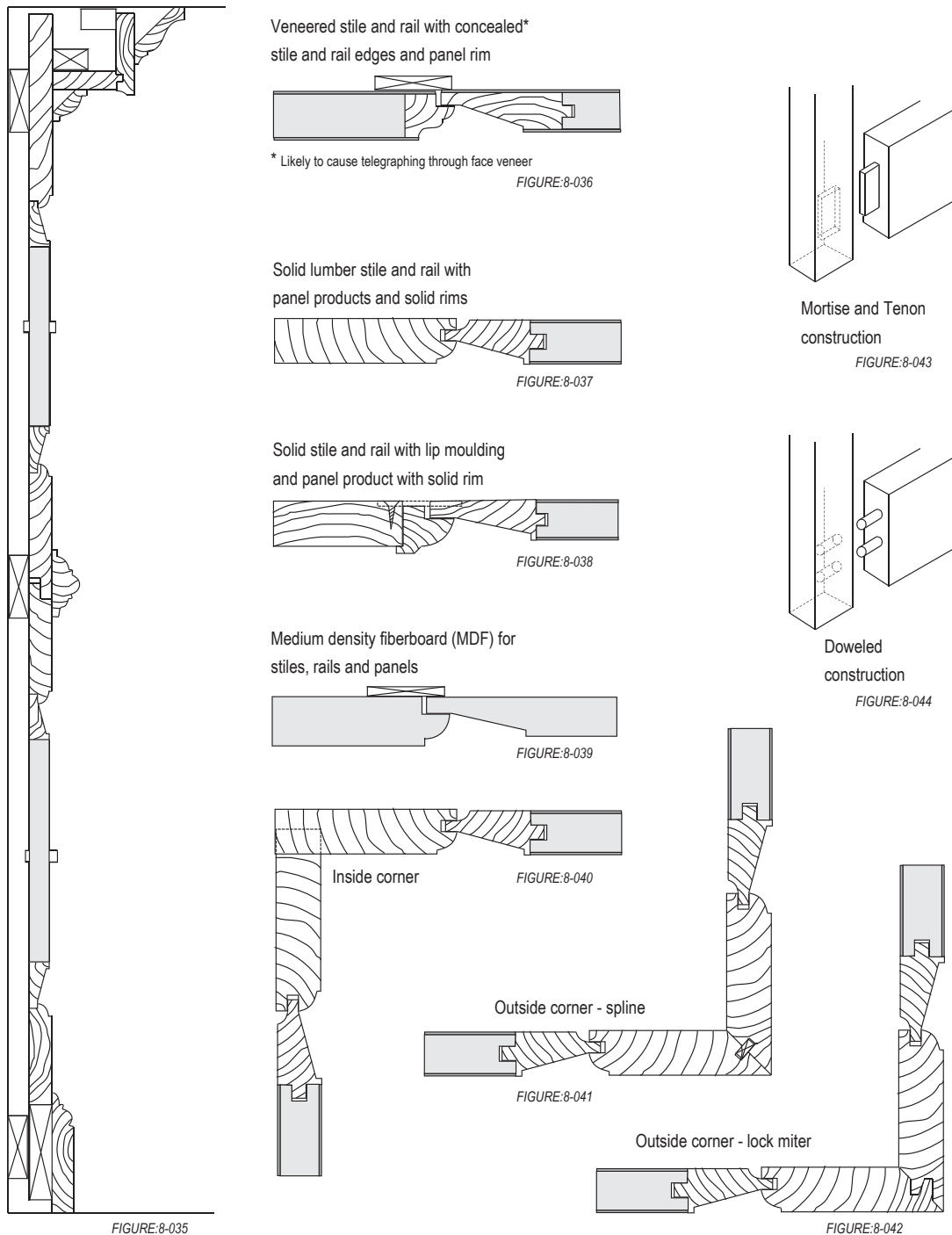

SECTION 8

Wall/Ceiling Surfacing and Partitions

introductory information

EXAMPLES of STILE and RAIL PANELING

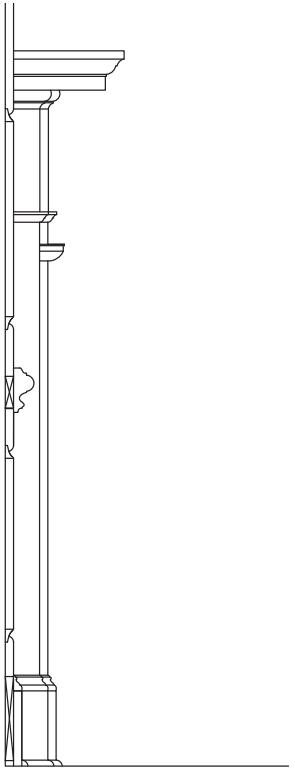
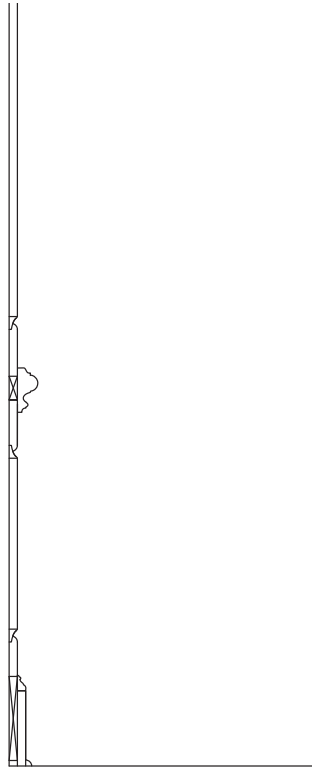
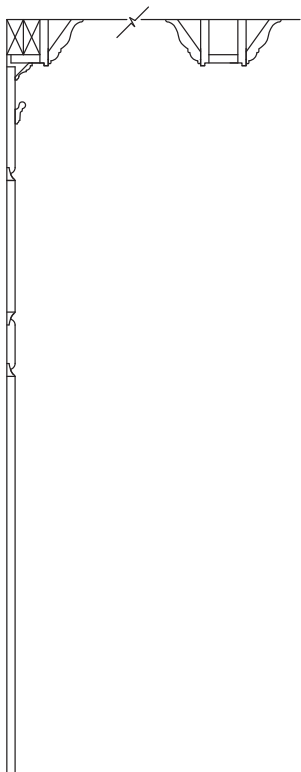
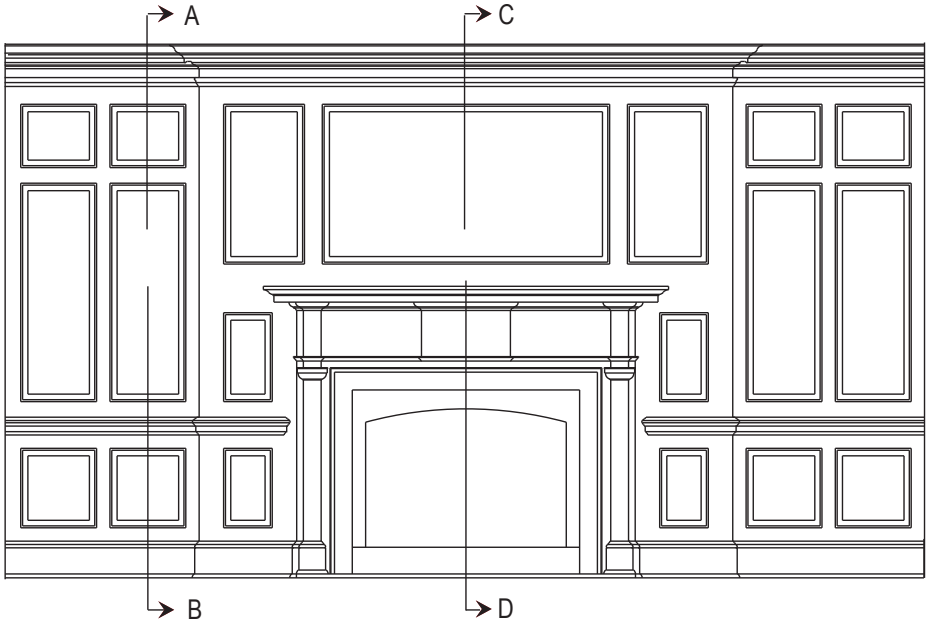

Section A

Section B

Section C

Section D

Figure: 8-045

8

introductory information

EXAMPLE of FLAT PANELING WITH REVEALS WITHIN A NICHE

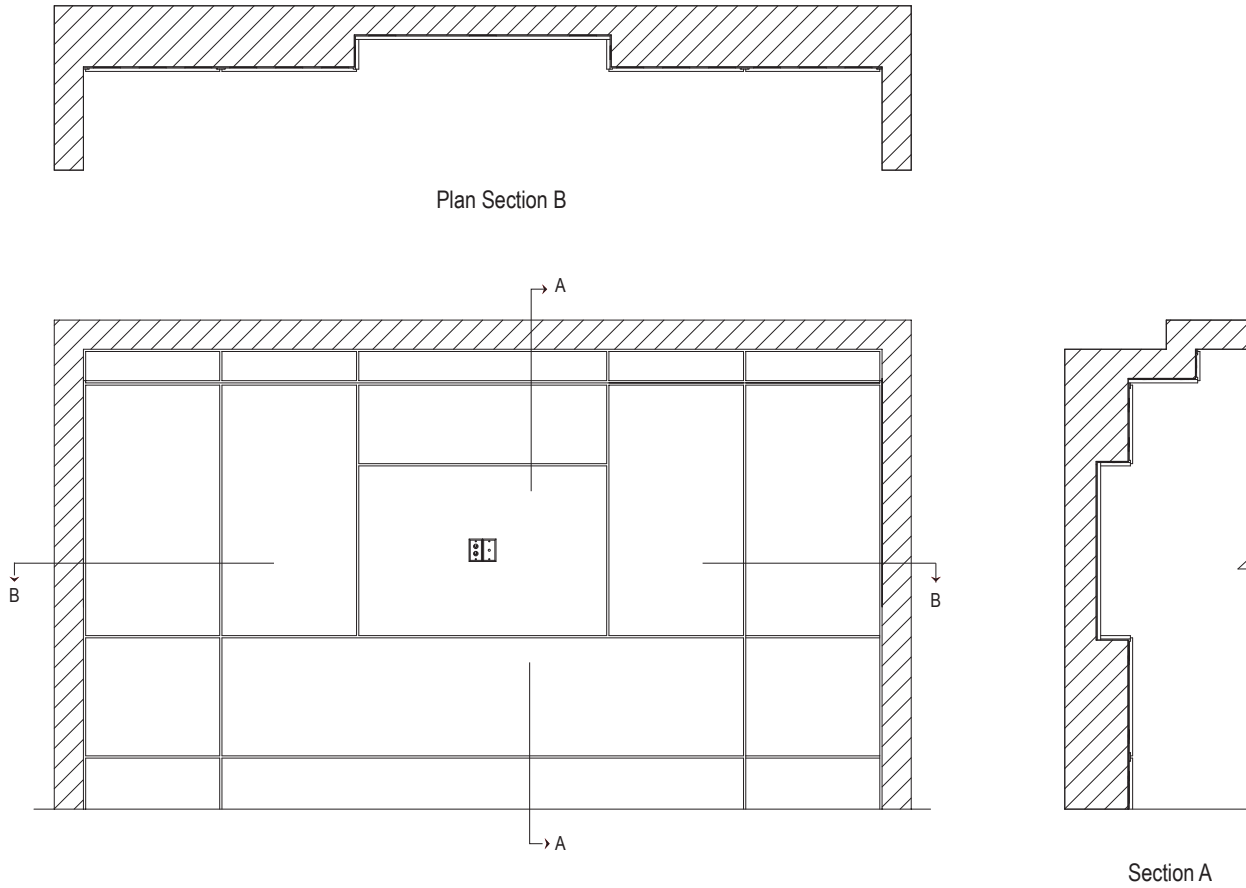

Figure: 8-046

SECTION 8

Wall/Ceiling Surfacing and Partitions

introductory information

EXAMPLE of PANELING FOR RECEPTION WALLS WITH FACTORY BUILT STRUCTURES

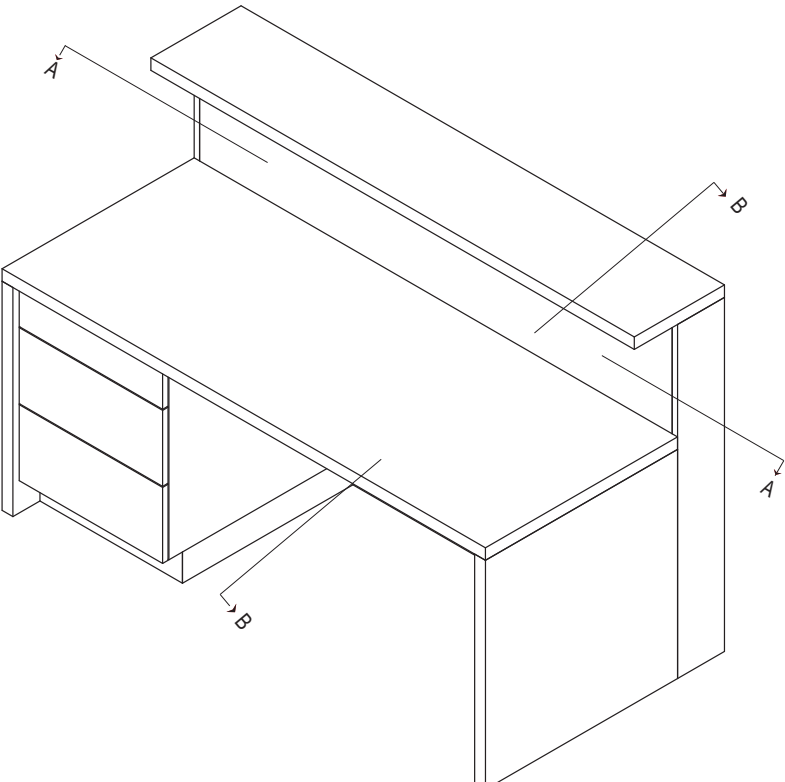

8

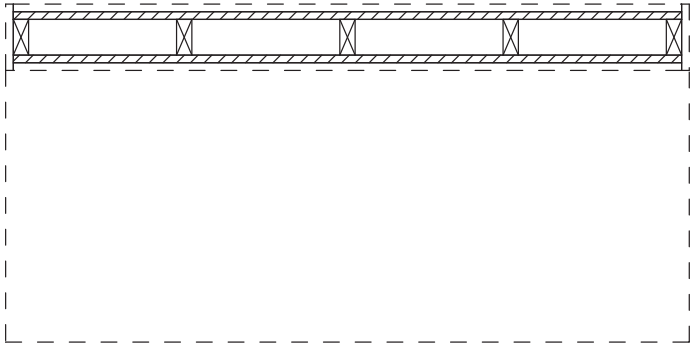

Plan Section A

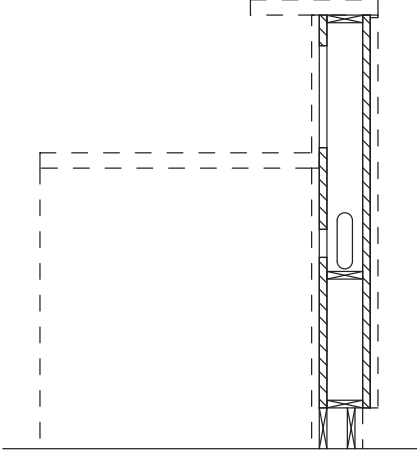

Section B

Figure: 8-047

You can now download for **FREE** a copy of the Architectural Woodwork Standard, ED 2 for a complete AWS document including compliance requirements, product information and more.

To Access

STEP 1

Create and sign up for an account on the [AWI Publications Store](#).

STEP 2

Navigate to “Standards Download’ under the Category filter, and select “**+ADD TO CART**” on either the:

Architectural Woodwork Standard, ED 2 Redline (Digital Download)

OR

Architectural Woodwork Standard, ED 2, 2014 Redline with Current Standards Watermark As of 6/01/2020 (Digital Download)

The watermarked version of the AWS helps you to navigate the Standards based on the release of the recognized AWI Standards. ***OR**, See a [Roadmap to the AWI Standards](#) to help you navigate them as well.

Get Started